

## Thermal Decomposition Measurement of ABS resin I

- Analysis by Quasi-Isothermal TG and TG/FT-IR Measurements -

### 1. Introduction

Thermogravimetry (TG) can investigate the decomposition temperature and weight decrease of samples and has many applications, including heat-resistance evaluations of various polymers and the analysis of thermal decomposition behaviors. One TG analysis method is quasi-isothermal thermogravimetry<sup>1)</sup>. This method uses temperature control to temporarily stop heating when weight decreases start. This makes it possible to separate the multiple stages of reactions at adjacent temperatures, which produces more accurate TG measurements.

Furthermore, TG can be combined with other methods, including Fourier Transform Infrared Spectrophotometers (FT-IR), Mass Spectroscopes (MS), and Gas Chromatography Mass Spectroscopes (GC-MS) to analyze thermal decomposition behavior during TG measurements in more detail<sup>2,3)</sup>. FT-IR, MS and GC-MS analysis of the components of decomposition gases from TG has been gaining force in recent years because it can determine composition, identify additives and more closely analyze thermal decomposition behavior.

As an example of TG analysis of ABS resin, this brief presents the results of combining the quasi-isothermal and the TG/FT-IR measurement methods to more closely analyze the thermal decomposition behavior of ABS resin<sup>4)</sup>.

ABS resin is composed of three components (Figure 1): acrylonitrile (A), butadiene (B), and styrene (S). It has a complex molecular structure with the AS resin phase (copolymers of acrylonitrile and styrene) as the continuous phase and the polybutadiene rubber phase grafted with acrylonitrile and styrene as the dispersal phase. Due to this complex structure, complicated thermal decomposition reactions occur during TG analysis of ABS resin and many types of decomposition gases are formed. The experiment presented here shows that a one-stage decomposition reaction in the constant-rate TG analysis of ABS resin was separated into two-stages when measured by quasi-isothermal methods. Furthermore, FT-IR analysis of the gases formed showed that the each stage of the two-stage decomposition reaction each produced different decomposition gases.

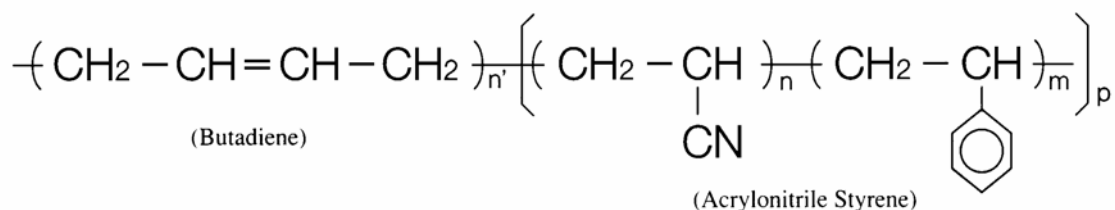
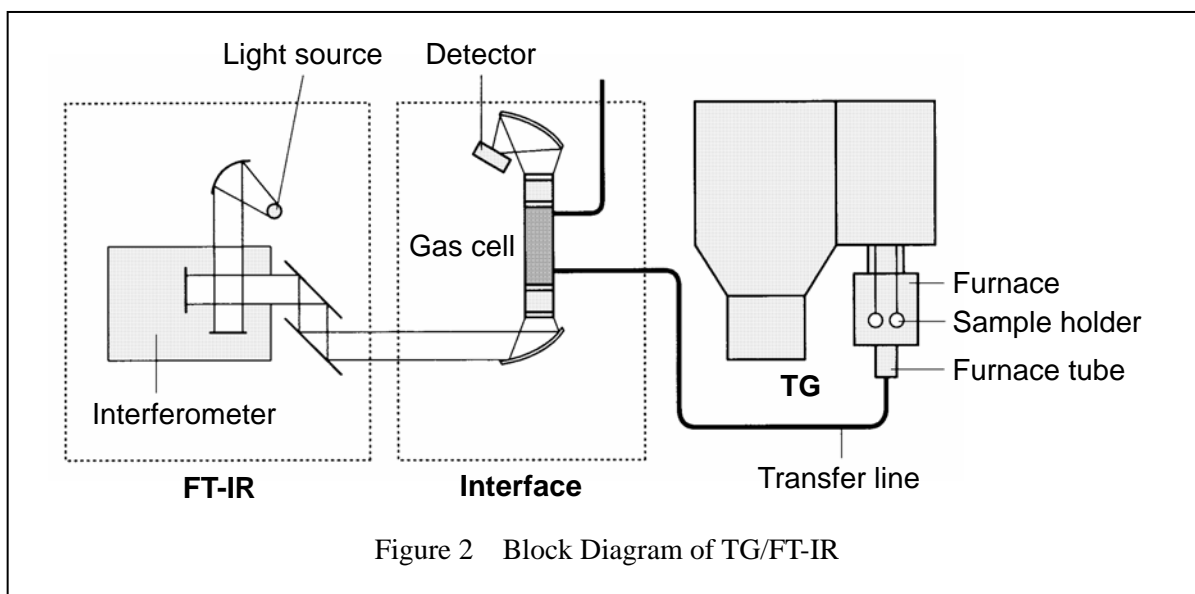

Figure 1 Chemical Structure of ABS resin



## 2. Measurements

Commercially available boards (moldings) of ABS resin were used as samples.

A TG/DTA220 Thermogravimetry / Differential Thermal Analyzer was connected to a SSC5200H Disk station. A gas transfer system was connected to the TG/DTA to direct the formed gases to a FT-IR gas cell. Figure 2 is a block configuration diagram of the entire system.

For the TG/DTA measurements, both the constant heating rate mode and controlled rate mode (quasi-isothermal method) used a heating rate of 20°C/min from room temperature to 700°C. The measurement sample weight was 10mg and a platinum sample container was used. The atmosphere was N<sub>2</sub> and the flow rate was 200ml/min. For the FT-IR measurements, the wave number resolution was 8cm<sup>-1</sup>, the resolution time was 1.7seconds per spectrum and a DTGS detector was used. Furthermore, the gas transfer line and gas cell temperature was set to 280°C.

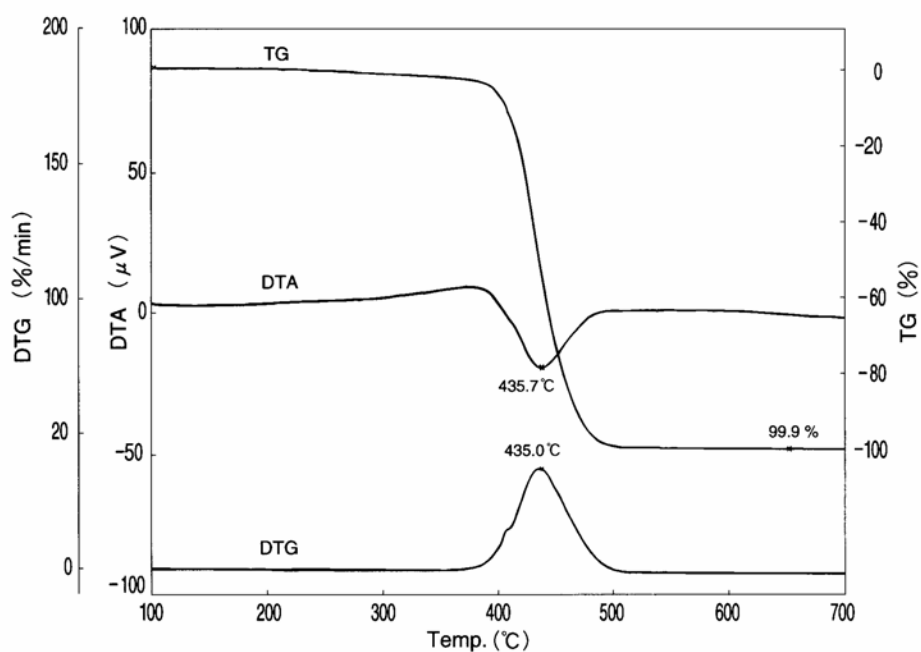

Figure 3 Constant Heating Rate TG/DTA Measurement Results for ABS resin

### 3. Measurement Results

#### 3-1 Constant Heating Rate Measurement Results

Figure 3 shows the TG/DTA measurement results for ABS resin at a constant heating rate. The TG curve shows a one-stage weight decrease between 350°C and 500°C. This is due to the thermal decomposition of the ABS resin and shows that roughly 100% had decomposed by 500°C. All the decomposition gas formed by this process was injected into the FT-IR gas cell using the gas transfer tube.

Figure 4 shows the IR absorption spectrum of the decomposition gas at 20°C intervals between 380°C and 520°C. Comparing the IR absorption spectra by temperature shows that the peak wave number and intensity differed by temperature. In particular, using the wave number 3000cm<sup>-1</sup> as a boundary shows that the high and low wave number absorption peaks invert in the vicinity of 440°C and 460°C. This result infers that the decomposition gases differ in the first and second half of the decomposition process.

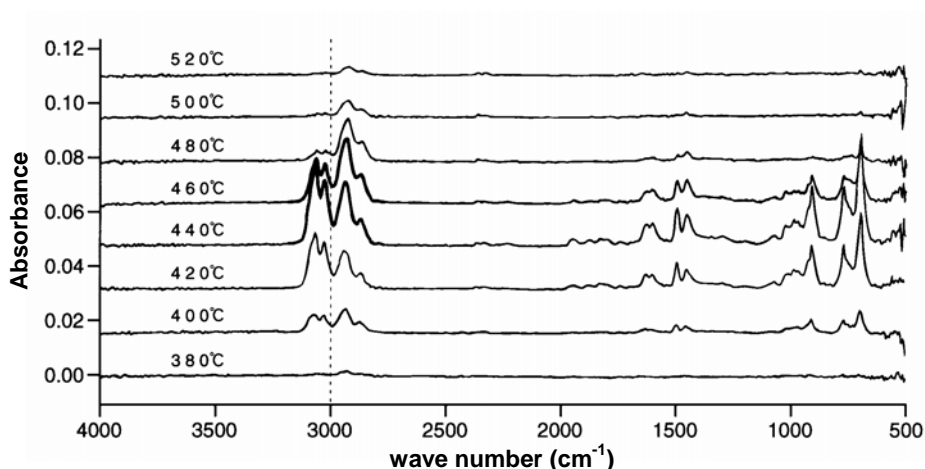

Figure 4 IR Absorption Spectra for ABS resin Decomposition Gases between 380°C and 520°C

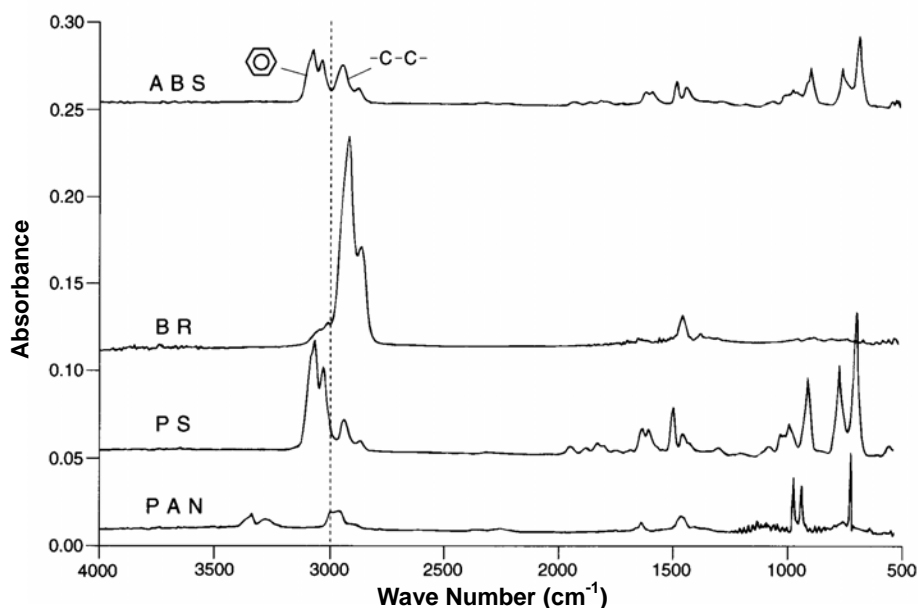

Figure 5 IR Absorption Spectra for ABS resin, PAN, BR and PS Decomposition Gases

Figure 5 shows the IR absorption spectrum for the decomposition gas of ABS resin and the IR absorption spectrums for the decomposition gases of the components of ABS resin, polyacrylonitrile (PAN), butadiene rubber (BR) and polystyrene (PS). The IR absorption spectrums in Figure 5 are spectrums at the temperature with the highest decomposition rate. When focusing on the wave number of  $3000\text{cm}^{-1}$ , it can be seen that the absorption peak of the BR spectrum is between  $3000\text{cm}^{-1}$  and  $2700\text{cm}^{-1}$  and the absorption peak of the PS spectrum is between  $3200\text{cm}^{-1}$  and  $3000\text{cm}^{-1}$ . On the other hand, the PAN spectrum peak around  $3000\text{cm}^{-1}$  is comparatively small.

Peaks around wave number  $3000\text{cm}^{-1}$  are absorption peaks caused by stretching of the C-H bonds of hydrocarbons. A characteristic absorption band exists in  $3000\text{cm}^{-1}$  to  $2800\text{cm}^{-1}$  range due to straight-chain hydrocarbons. Accordingly, BR, with has a straight-chain molecular structure, forms a lot of decomposition gas from its straight-chain hydrocarbons and this causes the large absorption peak in this wave number range. Furthermore, a characteristic absorption band exists in the  $3200\text{cm}^{-1}$  to  $3000\text{cm}^{-1}$  range due to the stretching of the C-H bonds of aromatic hydrocarbons. Accordingly, PS, which holds benzene rings, forms a lot of decomposition gas from the aromatic hydrocarbons and this causes a large absorption peak in this wave number range.

The IR absorption spectrum of the ABS resin decomposition gas can be considered as an overlapping of the IR absorption spectrums of the decomposition gases of its components, BR and PS. Accordingly, it can be assumed that the absorption peak between  $3200\text{cm}^{-1}$  and  $3000\text{cm}^{-1}$  seen in the low temperature range mainly reflects the decomposition of styrene and the absorption peak between  $3000\text{cm}^{-1}$  and  $2700\text{cm}^{-1}$  seen in the high temperature range mainly reflects the decomposition of butadiene.

### 3-1 Constant Heating Rate Measurement Results

Changes in the amounts of generated gas by temperature can be investigated by creating specific gas profiles (SGP).

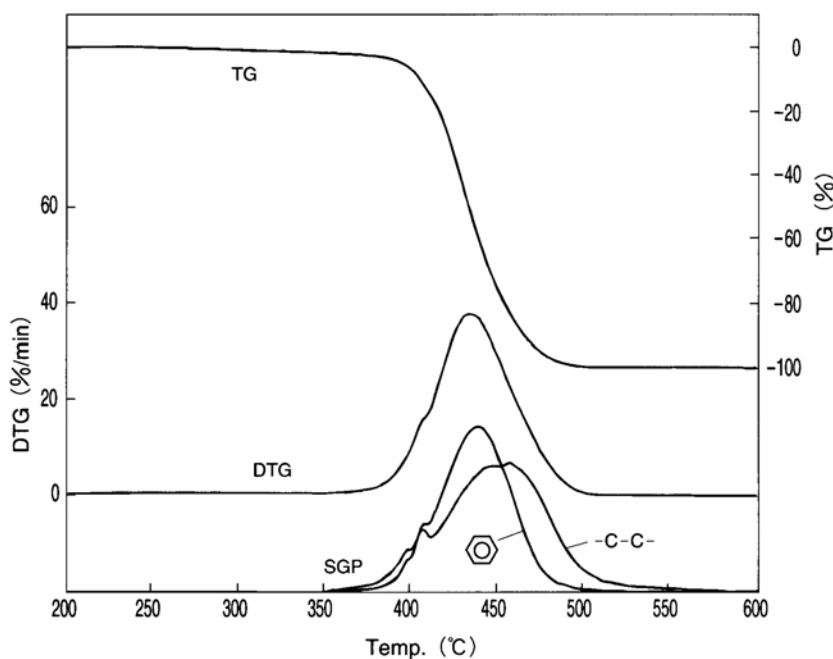

Figure 6 TG, DTG and SGP curves for ABS resin

Figure 6 shows the ABS resin TG and DTG curves, as well as the SGP curves for the two peaks around wave number  $3000\text{ cm}^{-1}$  in the ABS resin IR absorption spectrums of Figure 5. The aromatic hydrocarbons SGP curve peaks at roughly the same temperature range as the DTG curve. Conversely, the straight-chain hydrocarbons SGP curve peaks on the high temperature side of the decomposition process. Accordingly, while the ABS resin decomposition reaction appears to be one-stage in the TG curve of Figure 6, when the ABS resin components styrene and butadiene are separated, the difference in decomposition temperature of the two can be seen.

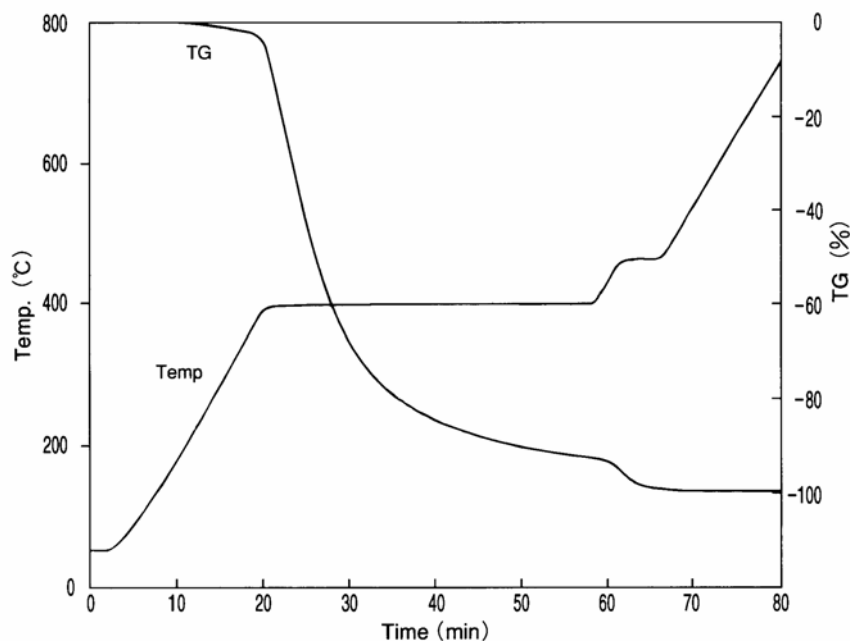

Figure 7 Controlled Rate Mode TG Measurement Results for ABS resin (Quasi-Isothermal Method)

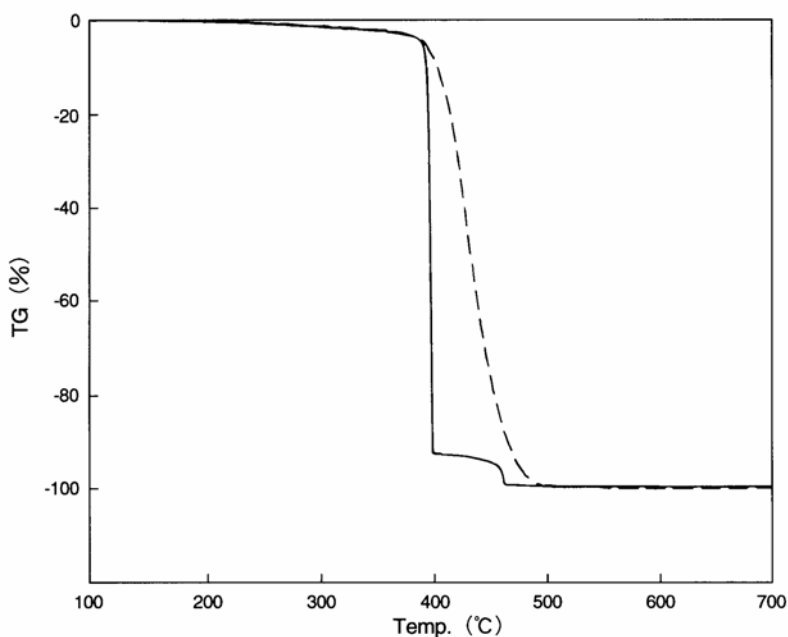

Figure 8 Comparisons of Constant Heating Rate and Quasi-Isothermal TG curves for ABS resin  
 ----- : Constant heating rate  
 ————— : Quasi-isothermal method

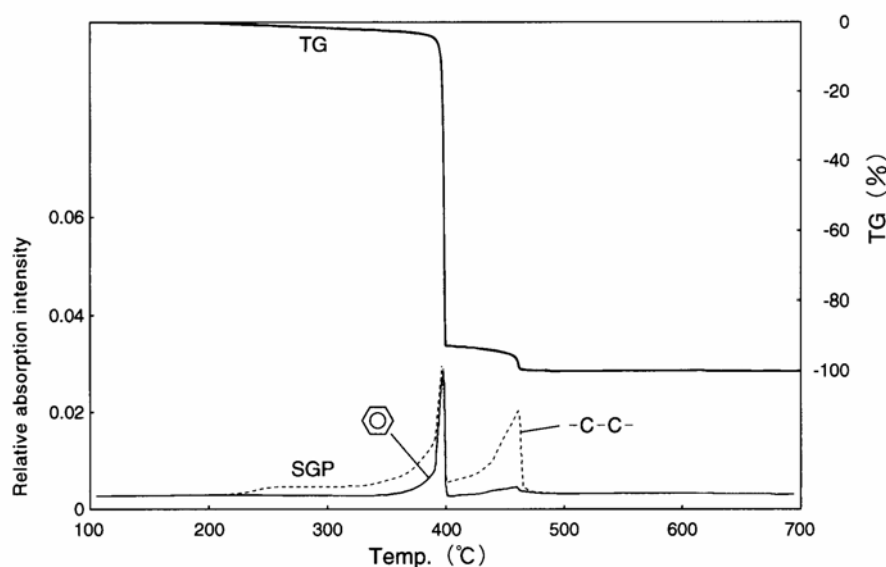

Figure 9 Quasi-Isothermal TG and SGP curves for ABS resin

### 3.2 Quasi-Isothermal Thermogravimetry Measurement Results

The results have shown that two components of ABS resin, styrene and butadiene, have different decomposition temperatures. In order to more precisely separate the decomposition reactions of the styrene and butadiene in ABS resin, quasi-isothermal thermogravimetric measurements were performed using controlled rate mode and the results are shown in Figure 7. Furthermore, Figure 8 shows a comparison of the TG curves from the Figure 7 quasi-isothermal results and the constant heat rate TG curve (Figure 3). This comparison shows that the constant heating rate measurement results show an apparent one-stage weight decrease while the quasi-isothermal results show two-stages.

Figure 9 shows the ABS resin quasi-isothermal TG curve and SGP curves. The SGP curves also observed two peaks corresponding to the two-stage TG curve.

When the first weight decrease occurred, both the straight-chain hydrocarbons and aromatic hydrocarbons SGP curves showed a peak. However, when the second weight decrease occurs, only the straight-chain hydrocarbon peaks. These results confirm that the two-stage ABS resin decomposition reaction found by the quasi-isothermal method corresponds to the styrene and butadiene components.

## 4. Summary

As an example of TG analysis of ABS resin, both quasi-isothermal thermogravimetric measurements and TG/FT-IR measurements were used to more clearly analyze ABS resin thermal decomposition behavior. This experiment showed that a one-stage decomposition reaction in the TG analysis of ABS resin using a constant heating rate was separated into two-stages when measured by quasi-isothermal methods. Furthermore, the FT-IR analysis of decomposition gas showed that the two-stage decomposition reaction corresponded to the decomposition of the styrene and butadiene components.

## Reference

- 1) Nobuaki Okubo, Application Brief TA No.63, SII NanoTechnology Inc. (1993)
- 2) R. Kinoshita, Y. Teramoto and T. Nakano, The 27th Japanese Conference on Calorimetry and Thermal Analysis, 1101A (1991)
- 3) R. Kinoshita, Y. Teramoto and H. Yoshida, *Netsu Sokutei*, **19**, 64(1992)
- 4) R. Kinoshita, T. Nakamura, Y. Ichimura and Y. Teramoto, The 28th Japanese Conference on Calorimetry and Thermal Analysis, 1116A (1992)